

EINSTÜCKBECKEN

Agua 51

Grundriss

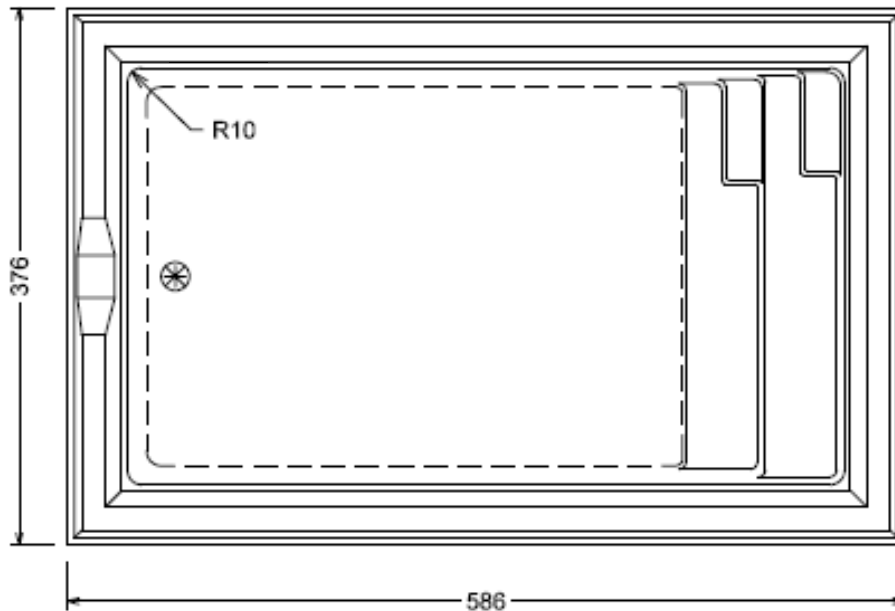

Seitenansicht

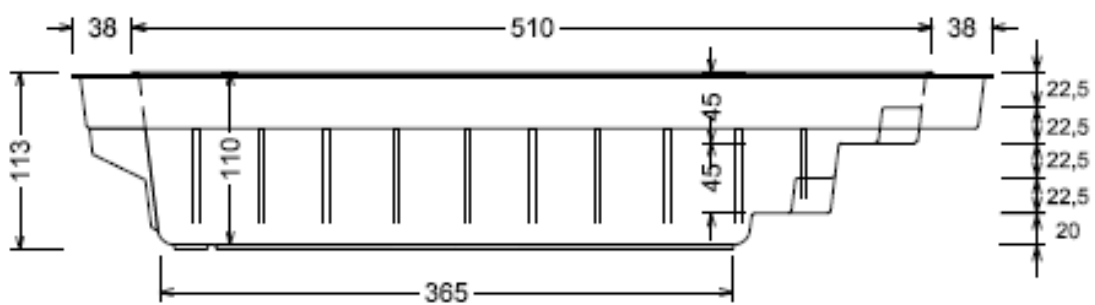

Ansicht Treppenseite

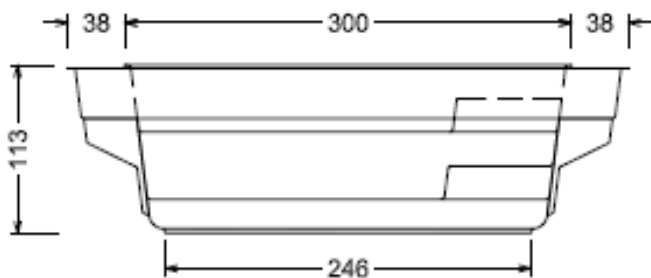

Ansicht Rückseite

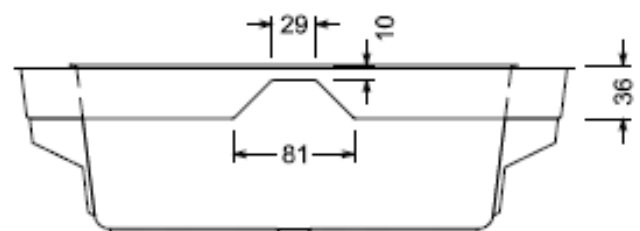

EINSTÜCKBECKEN

Agua 51

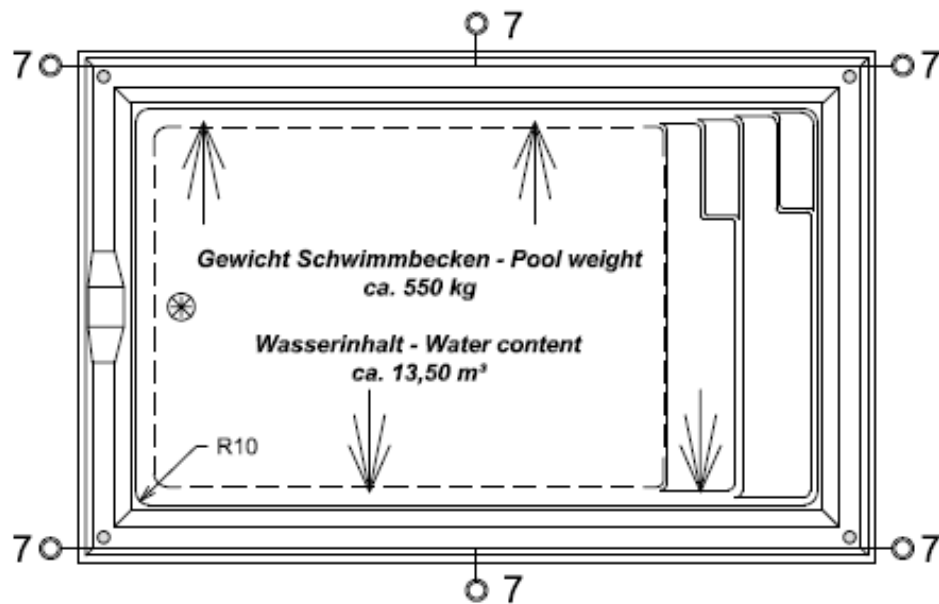

7 = Beckenstützen vertikal M20 Druck- und Zugstange
Vertical push and pull anchorages M20

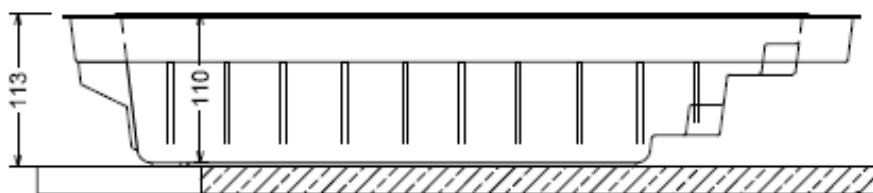
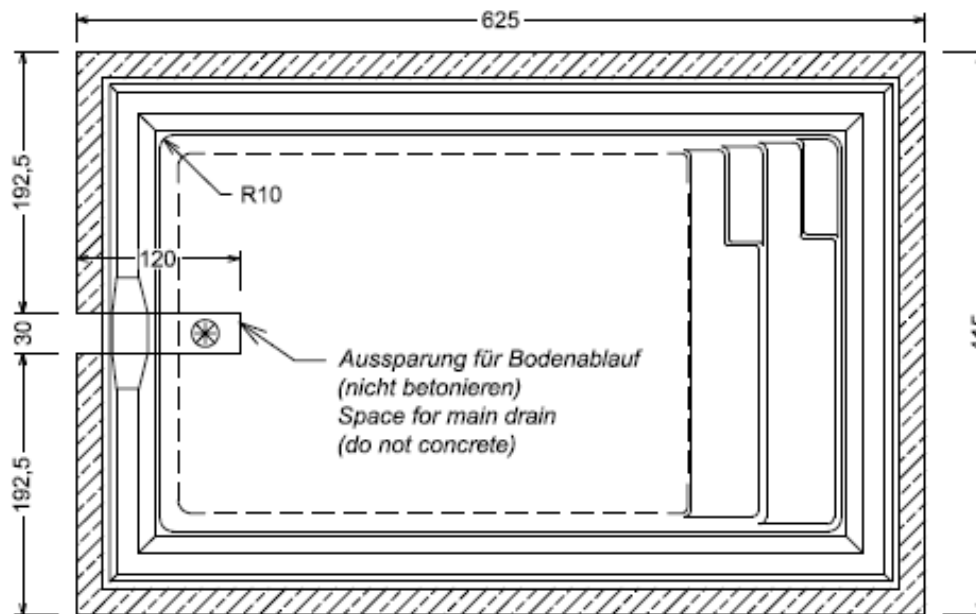

Fundamentplatte armiert laut örtlichen Bodenverhältnissen
Foundation slab, reinforced according to the local ground condition